

1. SAFETY PRECAUTIONS	19
2. INTENDED USE OF THE REFRIGERATOR	19
3. INSTALLATION AND CONNECTION	20
3.1 Choosing the site	20
3.2 Positioning and levelling the appliance	20
3.3 Electrical connection	20
4. PRODUCT DESCRIPTION	21
4.1 Shelves	21
4.2 Refrigerator compartment defrosting water drain	21
4.3 Fruit and vegetable box	21
5. ARRANGING FOODS INSIDE THE REFRIGERATOR COMPARTMENT	22
4.4 Door shelves and containers	22
4.5 Cheese box	22
4.6 Inside lighting	22
6. SETTING AND SELECTING THE OPERATING TEMPERATURE	23
7. FREEZING FOODS	23
7.1 Storing frozen foods	23
7.2 Thawing frozen foods	24
7.3 Making ice-cubes	24
8. MAINTENANCE AND CLEANING	25
8.1 Defrosting the refrigerator compartment	25
8.2 Defrosting the freezer	25
8.3 Cleaning the refrigerator	25
8.4 Switching off the refrigerator	25
8.5 Practical advice for saving energy	26
8.6 Operating noise	26
8.7 Identifying and Dealing with Malfunctions	26
8.8 Changing the inside light bulb	26
9. TROUBLESHOOTING GUIDE	27



INSTRUCTIONS FOR THE USER: these provide recommendations for use, a description of the controls and the correct procedures for cleaning and maintaining the appliance



INSTRUCTIONS FOR THE INSTALLER: these are intended for the **qualified engineer** who is to install, commission and test the appliance

DISPOSAL INSTRUCTIONS – OUR ENVIRONMENT POLICY

Our refrigerators are only packaged using non-pollutant, environment-friendly, recyclable materials. We urge you to cooperate by disposing of the packaging properly. Contact your local dealer or the competent local organisations for the addresses of collection, recycling and disposal facilities.

Never leave all or part of the packaging lying around. Packaging parts, and especially plastic bags, may represent a suffocation hazard for children.

Your old appliance must also be disposed of properly.

Important deliver the appliance to your local organisation authorised to collect scrapped appliances. Proper disposal allows the intelligent recovery of valuable materials. Refrigeration appliances contain gases which may damage the environment; it is important to ensure that the refrigeration circuit pipelines are not damaged until the competent service has taken delivery of the appliance.

Before scrapping your refrigerator it is important to remove doors and leave shelves in position as for use, to ensure that children cannot accidentally become trapped inside during play. Also, cut the power supply lead and remove it and the plug.

**NOTICE TO USERS:**

PURSUANT TO DIRECTIVES 2002/95/EC, 2002/96/EC, 2003/108/EC, RELATING TO THE REDUCTION OF THE USE OF HAZARDOUS SUBSTANCES IN ELECTRICAL AND ELECTRONIC EQUIPMENT, AND WASTE DISPOSAL, THE BARRED RUBBISH BIN SYMBOL ON THE APPLIANCE INDICATES THAT IT CANNOT BE DISPOSED OF AS HOUSEHOLD WASTE AT ITS END-OF-LIFE. THE USER MUST THEREFORE HAND THE PRODUCT OVER, AT ITS END-OF-LIFE, TO THE APPLICABLE COLLECTION CENTRES FOR THE RECYCLING OF ELECTRICAL AND ELECTRONIC WASTE, OR RETURN IT TO THE DEALER ON PURCHASE OF ANOTHER EQUIVALENT APPLIANCE, ON A ONE-FOR-ONE BASIS. CONSIGNING THE END-OF-LIFE APPLIANCE TO THE APPROPRIATE COLLECTION POINT FOR RECYCLING AND ECO-COMPATIBLE TREATMENT AND DISPOSAL PREVENTS POTENTIAL NEGATIVE EFFECTS ON THE ENVIRONMENT AND HUMAN HEALTH, AND HELPS ENSURE THAT THE PRODUCT'S COMPONENT MATERIALS WILL BE RECYCLED. UNLAWFUL DISPOSAL OF THE PRODUCT BY THE USER MAY LEAD TO PROSECUTION.

1. SAFETY PRECAUTIONS

Keep the instruction handbook in a safe place; it contains important information which must be applied when installing, using and servicing the refrigerator. The handbook must be kept so that it can be passed on to any subsequent owners of the appliance.

The manufacturer declines all responsibility in case of failure to comply with the following precautions:

- Do not attempt to operate a damaged appliance: in case of doubt, contact your dealer.
- The appliance must be installed and connected to the electrical mains in full compliance with the instructions provided in the handbook. The electrical connection conditions must be as specified on the nameplate , **which is in the bottom left-hand corner of the body of the refrigerator**. The appliance's electrical safety is only guaranteed if the household electrical system is earthed in accordance with the relevant regulations.
- Make sure that all repairs and servicing are only carried out **by authorised engineers from the Smeg after-sales service**. Always disconnect the appliance from the electrical mains in case of breakdown and maintenance, when changing light-bulbs or during cleaning. Never defrost using electrical devices or steam cleaners. Never remove frost or ice with sharp items, **as this may cause irreparable damage to the walls of the refrigerator**.
- Never attempt to move the refrigerator by pulling on the door or the handle.
- High-alcohol drinks must only be stored sealed and vertical. Never store liquids in cans or glass containers in the freezer compartment, especially if they contain added carbon dioxide. Never store products containing gases, flammable propellants or explosive substances in the freezer: explosion hazard!
- Do not use electrical equipment (such as ice cream makers or blenders) inside the appliance.
- To ensure the refrigerator operates correctly, never obstruct or cover the air ducts in any way.
- Never touch frozen products taken straight from the freezer or put them in your mouth. Burn hazard due to the very low temperatures.
- Never eat or drink foods which look or smell strange.
- **Never allow children to play with the refrigerator and use the drawers, shelves or other parts of the appliance only as described in this handbook; never use them for purposes other than those for which they are designed.**

In case of electricity blackout, open the door(s) as little as possible. Once partly or completely thawed, frozen foods must not be re-frozen.



Caution:

this refrigerator contains a small quantity of isobutane (R600a), a CFC-free gas refrigerant. When transporting, installing, cleaning and repairing the refrigerator, take care not to damage any parts of the refrigeration circuit to prevent the risk of gas leaks. In case of damage, do not use naked lights and ventilate the room containing the appliance appropriately.

2. INTENDED USE OF THE REFRIGERATOR

The appliance is specifically constructed for domestic use and is therefore suitable for the refrigeration and storage of fresh and frozen foods and the production of ice-cubes. The appliance has not been designed or manufactured for professional use. Smeg declines all responsibility for damage deriving from improper use of the appliance. The refrigerator has undergone all necessary tests regarding tightness of the refrigeration circuit and complies with the safety regulations for electrical appliances.



Caution:

the manufacturer declines all responsibility for injury or damage caused by failure to comply with the above regulations or deriving from tampering with even just one part of the appliance and the use of non-original spare parts.



3. INSTALLATION AND CONNECTION

3.1 Choosing the site

Always place the refrigerator in a dry place with satisfactory ventilation. Never expose it to direct sunlight or install it outdoors. Depending on its climate class (stated on the nameplate inside the refrigerator), the appliance can be used in different temperature conditions:

Class	Ambient temperature
SN (Subnormal)	from + 10° C to + 32° C
N (Normal)	from + 16° C to + 32° C
ST (Subtropical)	from + 18° C to + 38° C
T (Tropical)	from + 18° C to + 43° C

Never place the refrigerator close to heat sources. If this is unavoidable, a suitable insulating panel must be used to allow the appliance to function properly. Otherwise, place the appliance at least 3 cm from electric or gas cookers and at least 30 cm from combustion or radiation heating systems.

To allow proper cooling of the condenser, the refrigerator must not be placed too close to the wall. To prevent this, the appliance comes complete with two plastic spacers which must be fitted to the top of the condenser. If the refrigerator is installed underneath a wall cupboard, the distance between the two must be at least 5 cm.

Take care not to scratch or damage the floor when installing the appliance on parquet or linoleum. If necessary, when positioning slide the refrigerator over pieces of wood or a mat to the point decided for connection to the electrical mains.

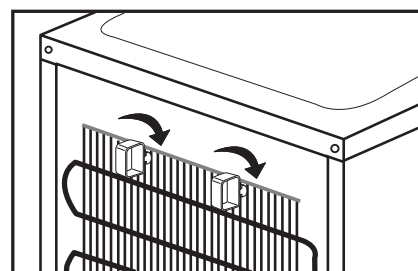

3.2 Positioning and levelling the appliance

Place the refrigerator on a firm, level surface. To compensate for any unevenness in the floor, the refrigerator has four adjustable feet. This gives it added stability and makes it easier to move around and position. Take great care when moving the appliance not to damage the floor (for example, when installing on a parquet floor).

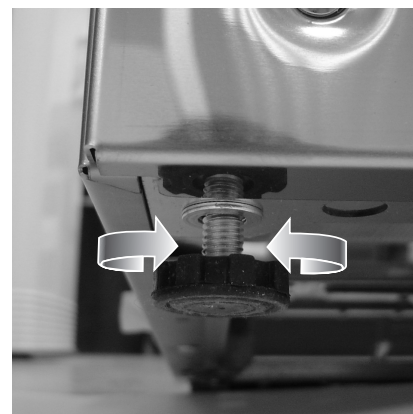

3.3 Electrical connection

Before switching the refrigerator on for the first time, leave it vertical for at least two hours. Then connect the appliance's power supply lead to a mains socket with earth contact, installed in accordance with electrical safety regulations. The rated voltage and frequency are stated on the nameplate inside the refrigerator compartment. The appliance must be connected to the electrical mains and earthed in compliance with the relevant regulations and requirements. The appliance is able to withstand short fluctuations in voltage of no more than 15% less or 10% more than the rated voltage stated on the nameplate. If the power supply lead has to be replaced, this operation must only be carried out by an **authorised Smeg technical service engineer**.

The power plug must be accessible after the appliance has been installed.



4. PRODUCT DESCRIPTION

- 1** Freezer section and ice-cube tray.
- 2** Inside light and thermostat knob.
- 3** Removable shelves.
- 4** Defrosting water collection channel.
- 5** Fruit and vegetable compartment lid.
- 6** Fruit and vegetable compartment.
- 7** Adjustable front and rear feet.
- 8** Dairy produce compartment.
- 9** Door compartments.
- 10** Egg compartment.
- 11** Bottle shelf.
- 12** Bottle retainer strut.

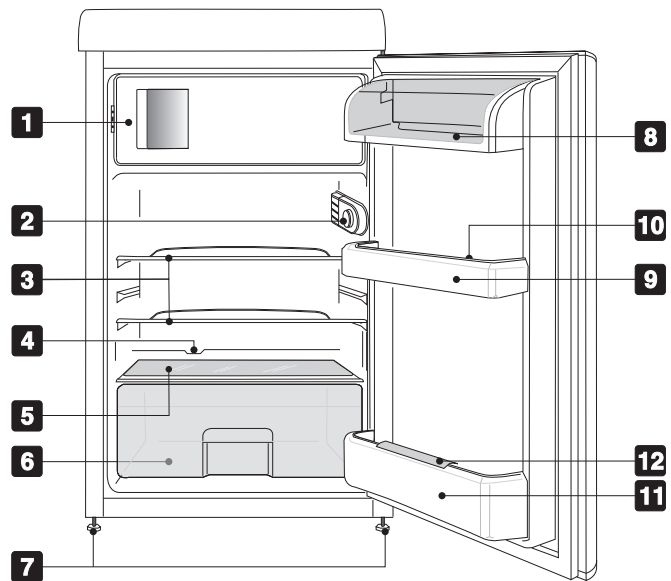

4.1 Shelves

The refrigerator comes complete with several shelves which can be set at different heights by placing them on the runners provided. Each shelf has a safety fitting to prevent it from being pulled completely out or accidentally removed. To remove it from the appliance, lift it at the back and extract it. Then change the position of the shelf or shelves as you require. For easy removal of all internal accessories, the door has to be opened completely.

4.2 Refrigerator compartment defrosting water drain

The rear of the refrigerator compartment, underneath the refrigerating plate, has a channel and a hole for collecting the defrosting water. To ensure the refrigerator can function properly, take care never to block this hole. It is best to check and clean it fairly regularly using the condensation drain funnel cap provided.

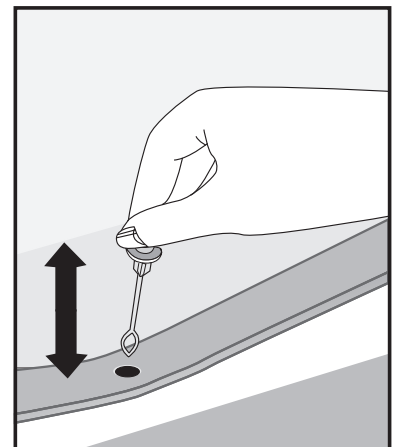

4.3 Fruit and vegetable box

this container is in the bottom of the refrigerator compartment, which is fitted with a glass shelf to cover fresh foods that require constant humidity for optimum storage.

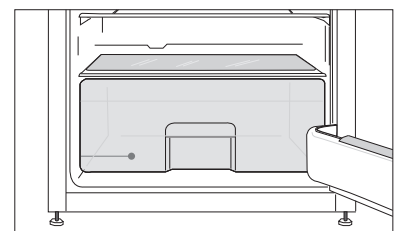



4.4 Door shelves and containers

The inside of the door is fitted with special shelves and boxes to take eggs, butter, dairy products, tubes, preserves and other small packages. The bottom of the door has a shelf to take vertical bottles.

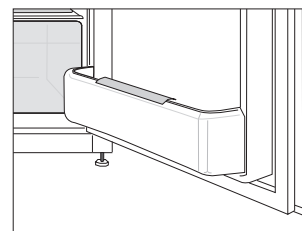

All door shelves and boxes can be removed for cleaning. To remove them from the door, tap them upward with your fist in the first on one side of the insertion zone and then on the other. Do not place excessively heavy bottles on the bottle shelf, and place bottles on the shelf gently when loading them.

4.5 Cheese box

A special cheese box with lid is supplied. This box can be placed on any shelf as required.

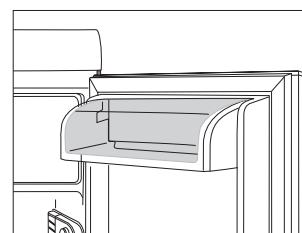

4.6 Inside lighting

When the refrigerator door is opened, the light comes on; it remains on until the door is completely closed again. The light comes on even if the refrigerator thermostat is set on "0", meaning that the refrigerator is switched off.

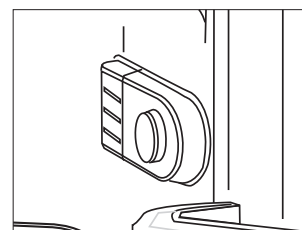

5. ARRANGING FOODS INSIDE THE REFRIGERATOR COMPARTMENT

Arrange the foods on the various shelves, taking care that they have an airtight wrapping or cover. This precaution will:

- conserve foods' fragrance, moisture and freshness;
- prevent the cross-contamination of foods with different aromas and tastes;
- prevent the humidity level inside the refrigerator becoming too high because of the normal breathing of food (especially fresh fruit and vegetables). In some operating conditions (rise in ambient temperature and humidity, more frequent opening of the door) this might cause condensation to form on the shelves.

Use only containers approved for food storage. Always allow hot foods and drinks to cool to room temperature before placing them inside the refrigerator.

Never store explosive substances in the appliance and only store high-alcohol drinks firmly sealed and vertical.



6. SETTING AND SELECTING THE OPERATING TEMPERATURE

The knob in the top right-hand corner of the refrigerator is used to set the operating temperature both in the refrigerator and in the freezer. When the knob is turned to **0**, the appliance is switched off. The operating settings are from 1 to 5. There is no direct correspondence between the setting chosen and the temperature in the two sections of the appliance. Increasing the setting number reduces the temperature inside the appliance. Only use the highest settings (4-5) if absolutely necessary: with these settings, the temperatures inside the refrigerator compartment may be close to 0°C and electricity consumption will be higher. In normal operating conditions, a medium-low setting (1-2) is recommended. This will provide effective storage of the fresh foods in the refrigerator compartment and of the frozen foods in the freezer compartment.

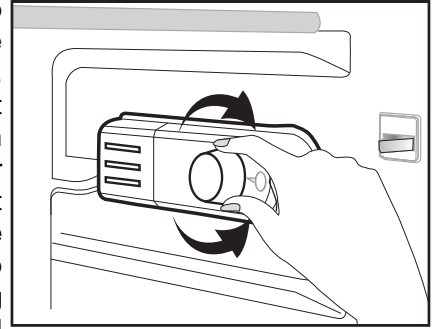

The temperature setting in the freezer section is controlled by the main thermostat.



Important

Changes in weather conditions (temperature and humidity) and the frequency with which the doors of the two separate compartments are opened may affect the refrigerator's operating temperatures.

7. FREEZING FOODS

For proper storage and freezing, fruit and vegetables should be packed in portions of not more than 1 kg and meat and fish up to a max. of 2 kg. Small packages of food freeze more quickly, giving better conservation of their nutrients and flavour, even after thawing and preparation. Use only freezer bags, aluminium film, food-approved polyethylene film and freezer containers. Do not use paper bags, non food-approved cellophane bags, shopping bags or used freezer bags. Pack foods in airtight packs and try to expel all the air. If using bags, close the packs with the elastic bands or plastic-coated wire strips provided. Always cool hot foods to room temperature before placing them in the freezer and do not allow frozen foods to touch fresh foods for freezing. Always mark packs with the date of freezing, quantity and type of food and make sure that foods are fresh and in good condition. The max. amount of fresh foods which can be frozen in a 24-hour period is marked on the nameplate. Do not exceed the stated amount: this reduces the freezer's efficiency and its ability to preserve the frozen foods it already contains.

7.1 Storing frozen foods

When purchasing frozen foods, always take care that the pack is not damaged, that the product is not past its sell-by date and that the thermometer of the freezer in which the products are displayed for sale does not show a temperature above -18°C. Also note the temperature advice, storage period and modes of consumption stated by the producer. Purchased foods should also be protected using suitable insulated containers during transportation to eliminate the risk of thawing. An increase in temperature might reduce their storage life and adversely affect their quality.

Do not purchase frozen foods which have too much frost on them: they may have already been thawed and refrozen.



FOOD	STORAGE PERIOD (IN MONTHS)											
	1	2	3	4	5	6	7	8	9	10	11	12
Vegetables								+	+	+		
Fruit										+	+	+
Bread - Confectionery			+									
Milk			+									
Ready-meals			+									
Meat: beef										+	+	+
veal								+	+	+		
pork				+	+	+						
poultry								+	+	+		
game						+	+	+				
minced meat				+								
Smoked sausage	+											
Fish: oily			+									
lean	+											
Offal		+										



To prevent deterioration of frozen foods, do not exceed the permitted storage date, which depends on the type of food.

7.2 Thawing frozen foods

Partially thawed foods should be eaten as soon as possible. Low temperatures preserve foods but they do not destroy the micro-organisms which are activated after thawing, which may cause the stored foods to deteriorate. If thawed foods smell and look normal, they can be cooked and if required re-frozen once they have cooled.

Depending on their type and intended use, frozen foods can be thawed correctly at room temperature, in the refrigerator, in an electric oven (conventional or fan mode), or in a microwave oven using the relevant function.

7.3 Making ice-cubes

Fill the tray provided 2/3 full of water or any other liquid you wish to freeze. Place it in the freezer compartment, making sure that its bottom is dry so that it will not stick to the shelf of the compartment. To detach the ice-cubes, twist the tray slightly or place it under running water for a few seconds.



8. MAINTENANCE AND CLEANING

8.1 Defrosting the refrigerator compartment

The refrigerator compartment has automatic defrosting. During normal operation of the refrigerator, frost forms on its back wall when the compressor is working and dissolves when it is not in operation. When the compressor is not working, the frost which has built up on the back wall melts and the water flows into the opening provided in the bottom of the body of the refrigerator. From here, it flows into the tray on the compressor, where it evaporates.



Warning

The amount of ice which forms on the back wall may vary with changes in weather conditions (temperature and humidity), the frequency with which the door is opened, the appliance's operating temperatures and the amount of fresh foods stored inside (especially fruit and vegetables).

8.2 Defrosting the freezer

The freezer compartment has to be defrosted manually. When the thickness of frost or ice on the shelves exceeds 2 cm, the freezer should be defrosted. A few hours before defrosting, use the knob provided to set the thermostat on 5 in order to further lower the temperature of the frozen foods. Then turn the knob to the 0 setting and disconnect the plug from the electrical mains. Remove the frozen foods from the freezer compartment and protect them from thawing while cleaning. Place a container underneath the pipe to collect the defrosted water.

8.3 Cleaning the refrigerator

Before cleaning, disconnect the plug from the electrical mains. Clean the outside using only water and a gentle liquid detergent or an ordinary detergent for washable surfaces (such as a window-cleaning product). Never use products containing abrasives or substances which may attack the lacquered or painted parts, acids or chemical solvents. Use a sponge or a soft cloth.

Do not use steam cleaners to clean the inside; we recommend the use of refrigerator-specific disinfectants. Special SMEG brand steel cleaning products are available from our Service Centres.

Remove the shelves and accessories, taking care not to apply excessive force when removing. Follow the instructions provided in the "Door Shelves and Containers" section carefully. Never wash removable plastic parts in the dishwasher; use only warm water and washing-up liquid or water and vinegar. Take care not to wet the electrical lighting components with water or detergents.

Clean the seals with warm water and then dry.

To allow the refrigerator to operate at full efficiency, periodically also clean the condenser on the rear with a brush or a vacuum cleaner.



Also make a periodic check on the tray above the compressor, and clean it if necessary.

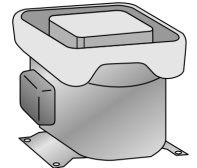

8.4 Switching off the refrigerator

If the refrigerator is to be out of use for some time, turn the thermostat knob to 0. Then empty the compartments, disconnect the appliance from the electrical mains, and once it has defrosted dry any residual moisture which has collected. Leave the door ajar to prevent the humidity and trapped air from creating unpleasant smells.



8.5 Practical advice for saving energy

- Install the refrigerator in a cool, well ventilated place, protected against direct sunlight and well away from heat sources.
- Do not place hot foods in the refrigerator or freezer sections. Wait for foods and drinks to cool to room temperature before placing them on the shelves;
- Open the door(s) as infrequently and for as short a time as possible to prevent the compartments from warming up too much;
- Clean the condenser (rear of the refrigerator) periodically to prevent the appliance from losing efficiency;
- On models equipped with intensive cooling and rapid freezing, do not leave these functions activated for longer than absolutely necessary;
- If the refrigerator is to be out of use for a long period, it is best to empty it and switch it off;
- Thaw frozen foods in the body of the refrigerator in order to exploit the cold stored in the frozen foods, which will be transferred to the refrigerator if this procedure is used.

8.6 Operating noise

The refrigerator and freezer are cooled by means of a compression system. In order to maintain the preset temperature inside the refrigerator and freezer sections, the compressor comes into operation in response to the level of cooling required, and may operate continuously if necessary. When the compressor starts up a humming sound will be heard, tending to drop in volume after a few minutes. Another normal refrigerator operating noise is a gurgling due to the coolant flowing through the pipes in the circuit. This noise is perfectly normal and does not mean that the appliance is malfunctioning. If it is over-loud, there may be other causes. In this case, check that:

- The refrigerator is properly levelled on the floor and does not vibrate when the compressor is in operation: **adjust the feet provided as appropriate**;
- The drawers, shelves and door boxes are correctly fitted and securely in place: **fit correctly**;
- **Bottles and containers on the various shelves are stable and not touching**: the vibration due to operation of the compressor may generate some noise;
- Do not place **kitchen units or other appliances so that they are touching the refrigerator**.

8.7 Identifying and Dealing with Malfunctions

Your new refrigerator is designed and built to strict quality standards. This section is intended to enable you to identify the origin of any malfunctions which may occur before contacting the Smeg After-Sales Service.

8.8 Changing the inside light bulb

Before changing the bulb, make sure that the light has not stopped working simply because the part inside the lamp socket has become loose. In all cases, whether you wish to check that the socket is connected correctly or change the bulb, **for safety reasons the plug must be removed from the power socket.** (It may be useful to remove the shelves for easier access).

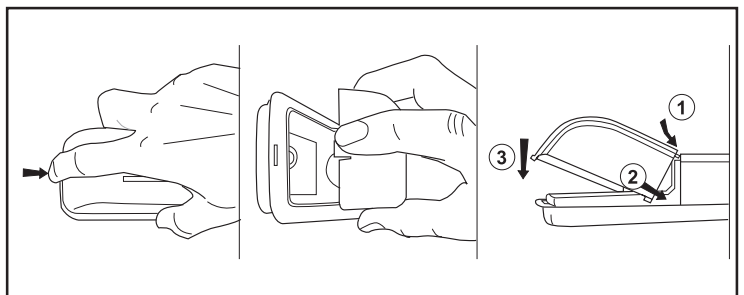

Unscrew the bulb to remove it from the socket. Replace the bulb with another having the same characteristics (E14, max 15 W), screwing the new one into place.



9. TROUBLESHOOTING GUIDE

PROBLEM	POSSIBLE CAUSE	PROBABLE SOLUTION
Noisy operation:		- see "operating noise" section
The compressor starts up too often or operates continuously:	<ul style="list-style-type: none">- compressor and condenser cooling inadequate:- rise in outside temperature;- doors opened often or for long periods;- too much fresh food placed in the appliance.	<ul style="list-style-type: none">- check that the rear of the appliance is properly ventilated as explained in point "3.1 Choosing the site" and that the condenser is not over-dirty;- freeze less food at a time.
The compressor does not start up:	<ul style="list-style-type: none">- temperature regulator on 0.- power supply lead not connected to the electrical mains;- mains socket not supplying electrical power.	<ul style="list-style-type: none">- connect the cable to the power supply;- contact the utility company.
Refrigerator section not cooled sufficiently:	<ul style="list-style-type: none">- inside temperature setting thermostat set too low (1-2) (this corresponds to higher interior temperature);- door opened often or for long periods;- door not closing properly;- rise in outside temperature.	<ul style="list-style-type: none">- Turn the regulator to an intermediate setting (3-4);- open the door less often and for as short a time as possible;- check that the foods are arranged on the shelves correctly and are not preventing the door from closing properly, and that the refrigerator is well levelled on the floor;- check that the gasket is sealing properly and is not damaged.
Water in bottom of refrigerator:	<ul style="list-style-type: none">- "Condensation drain" opening blocked or frozen.	<ul style="list-style-type: none">- Clear the drain opening.
Door hard to open just after closing:		<ul style="list-style-type: none">- if you attempt to open a door again just after closing it (especially the freezer door), considerable strength is required. This is because of the vacuum caused by cooling of the warm air that has entered the appliance.



PROBLEM	POSSIBLE CAUSE	PROBABLE SOLUTION
Temperature inside freezer not low enough to freeze foods properly:	<ul style="list-style-type: none"> - inside temperature setting thermostat set too low; - door opened often or for long periods; - door not closing with an airtight seal; - too much sugar in foods for freezing. 	<ul style="list-style-type: none"> - Turn the regulator to an intermediate setting (3-4); - open the door less often and for as short a time as possible; - check that the foods are arranged on the shelves correctly, that the gasket is sealing properly and is not damaged, and that the refrigerator is well levelled on the floor; - some foods can only be completely frozen at very low temperatures (ice-cream, concentrated fruit-juices).
Too much condensation forming in refrigerator section:	<ul style="list-style-type: none"> - check that the door gaskets are providing an airtight seal on the refrigerator; - door opened often or for long periods; - too much fresh food (fruit and vegetables) placed on the shelves; - foods not properly covered or stored in airtight containers. 	<ul style="list-style-type: none"> - In case of cracks, try to soften the gasket by pulling it with one hand and sliding your closed fingers along the inside; - open the door less often and for shorter times, especially when the appliance is working in warm, humid conditions; - place less food inside the refrigerator section; - Cover the containers and seal foods.
Temperature inside refrigerator section too cold - fresh foods are freezing:	<ul style="list-style-type: none"> - cooling temperature regulator device set too high (meaning lower temperature inside the appliance). 	<ul style="list-style-type: none"> - Turn the regulator to a lower setting (1-2); - cover foods using suitable bags and containers; - do not place fruit and vegetables inside when too wet; - do not place foods inside touching the back of the refrigerator.



Instructions for the User

GB-IE

PROBLEM	POSSIBLE CAUSE	PROBABLE SOLUTION
Too much ice forming on back wall of refrigerator section (layer of frost more than 1 cm thick):	<ul style="list-style-type: none">- Cooling temperature regulator device set too high (meaning lower temperature inside the appliance);- door opened often or for long periods.	<ul style="list-style-type: none">- Turn the regulator to a lower setting (1-2) to increase the temperature inside the appliance slightly;- check that the gaskets are providing an airtight seal;- open the door less often and for shorter times;- rise in atmospheric temperature and humidity;- do not place hot food or drinks inside the refrigerator.
Too much ice forming in freezer:	<ul style="list-style-type: none">- inside temperature setting thermostat set on too low a temperature:	<ul style="list-style-type: none">- Turn the regulator to a lower setting (1-2) to increase the temperature inside the appliance slightly;- check that the gaskets are providing an airtight seal: If they are cracked, try to soften the gasket by pulling it with one hand and sliding your closed fingers along the inside;- open the door less often and for shorter times;- rise in atmospheric temperature and humidity;- do not place hot food or drinks inside the freezer.
Front of cabinet hot to the touch:		<ul style="list-style-type: none">- the refrigerator is operating normally. Inside the cabinet there is a surface heating system designed to restrict the formation of condensation in the area where the door gasket closes.



PROBLEM	POSSIBLE CAUSE	PROBABLE SOLUTION
Condensation forming on the gasket of the freezer compartment door or on the wall of the refrigerator compartment next to this door:	- The gasket is not providing an airtight seal on the freezer compartment.	- Adjust the hinge if necessary: undo the two screws and raise or lower the hinge slightly as required. Then tighten the screws to fix it in place. If the condensation is on the top, raise the hinge; if it is on the bottom, lower it; - open the door less often and for shorter times, especially in warm, humid weather conditions.

AFTER-SALES SERVICE - READING THE NAMEPLATE.

IF THE PROBLEMS WITH THE PRODUCT YOU HAVE PURCHASED ARE NOT AMONGST THOSE DESCRIBED ABOVE AND IF YOU NEED MORE INFORMATION, PLEASE CONTACT THE AUTHORISED AFTER-SALES SERVICE. YOU WILL FIND THE ADDRESS AND TELEPHONE IN YOUR LOCAL TELEPHONE DIRECTORY UNDER **SMEG**.

TO SPEED UP THE SERVICE, PLEASE BE READY TO INFORM OUR CALL SERVICE OPERATORS OF THE MODEL OF THE PRODUCT YOU HAVE PURCHASED AND THE SERIAL NUMBER MARKED ON THE NAMEPLATE INSIDE THE BODY OF THE REFRIGERATOR. THANK YOU IN ADVANCE FOR YOUR ASSISTANCE.